

- ^{ぶんどき}分度器の中心を点アに合わせて次の角度をかきましょう。

1 145°

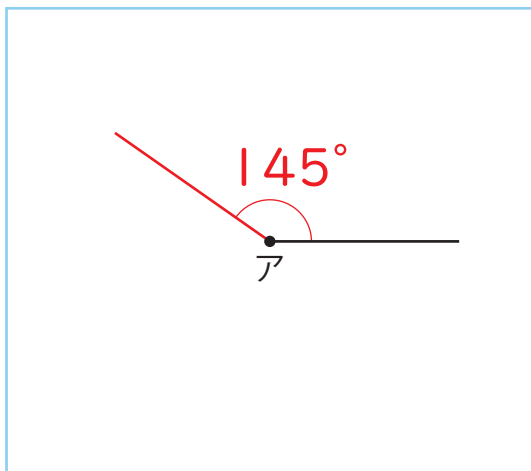

2 260°

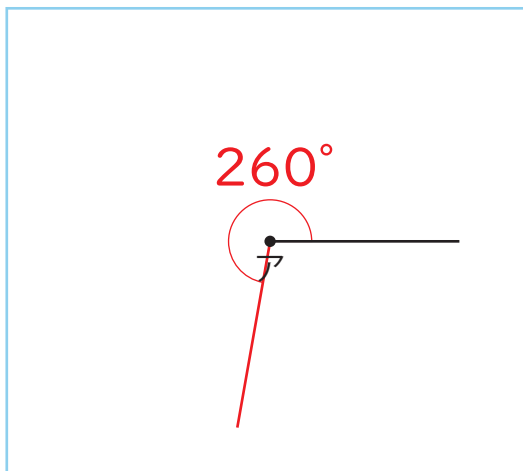

3 65°

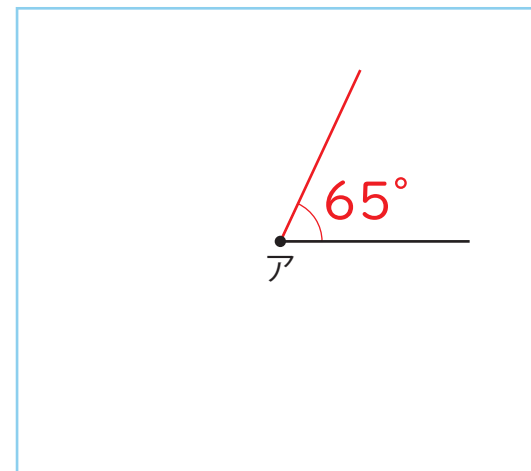

4 295°

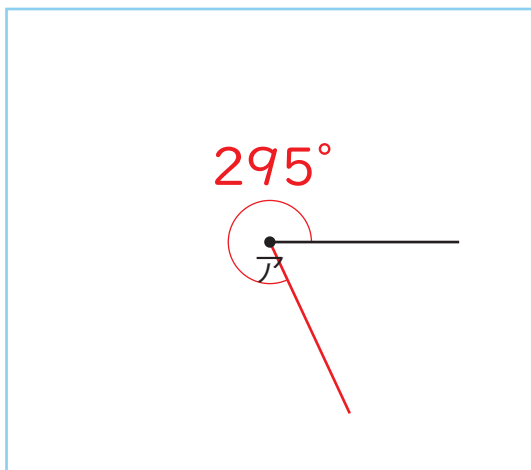

5 105°

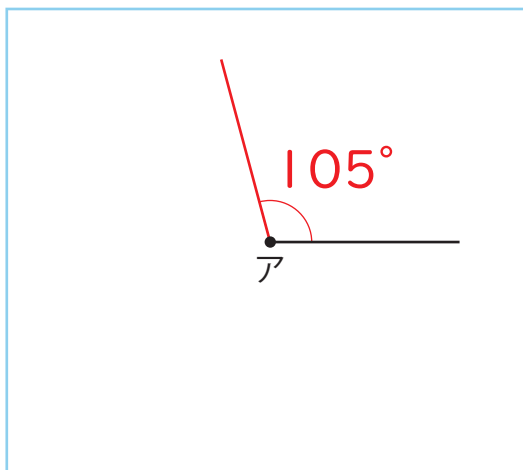

6 325°

